

# INSTALLATION AND USER MANUAL

Thank you for choosing Fairland Full-inverter heat pump.  
This manual provides you necessary information for  
optimal use and maintenance, please read it carefully and  
keep it for subsequent use.

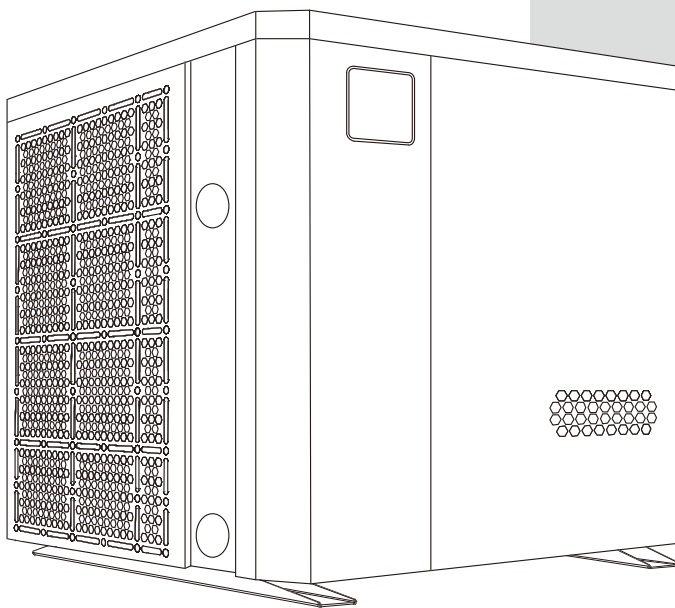



# CONTENT

<b><i>For users</i></b> .....	<b><i>P.3-P.9</i></b>
1. GENERAL INFORMATION .....	3
1.1. Components:.....	3
1.2. Operating conditions and range: .....	3
1.3. Benefits in different modes: .....	3
1.4. Cautions: .....	4
2. OPERATIONS.....	6
2.1. Notice before use .....	6
2.2 Operation instructions.....	6
2.3. Daily maintenance and winterizing.....	8
2.3.1. Daily maintenance .....	8
3. TECHNICAL SPECIFICATION .....	9
<b><i>For installers and professionals</i></b> .....	<b><i>P.10-P.26</i></b>
1. TRANSPORTATION.....	10
2. INSTALLATION AND MAINTENANCE.....	10
2.1.Before installation: .....	10
2.2.Installation instruction .....	11
2.3.Trial after installation.....	14
2.4.Maintenance and winterizing .....	14
3.TROUBLE SHOOTING FOR COMMON FAULTS .....	15
4. FAILURE CODE.....	16
APPENDIX 1: HEATING PRIORITY WIRING DIAGRAM (OPTIONAL) .....	17
APPENDIX 2: HEATING PRIORITY WIRING DIAGRAM(OPTIONAL) .....	18
APPENDIX 3: HEATING PRIORITY WIRING DIAGRAM(OPTIONAL) .....	19
5. WIFI SETTING.....	21

## **PLEASE READ CAREFULLY AND KEEP FOR SUBSEQUENT USE**

This manual provides you necessary information for optimal use and maintenance



## Warning:

- a. Please read the following tips before installation, use and maintenance.
- b. Installation, removal and maintenance must be carried in accordance with the instructions.
- c. Before and after installation, if you detect any gas leakage the unit must be turned off and reported to your supplier.

### 1. Use

- a. Any maintenance work on the heat pump must be carried out only by a qualified Service Technician.
- b. Do not place put items on the heat pump.
- c. Do not block air outlet of the heat pump.

### 2. Installation

- a. This product must be kept away from any source of fire.

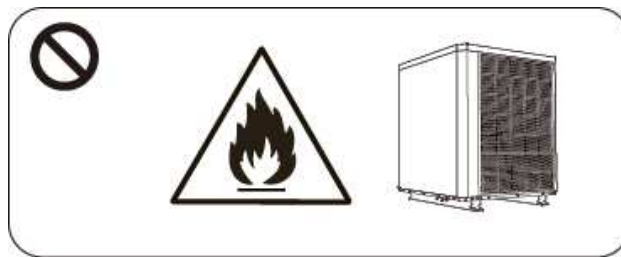

- b. The installation can't be in a closed environment or indoors, and must be kept well ventilated.

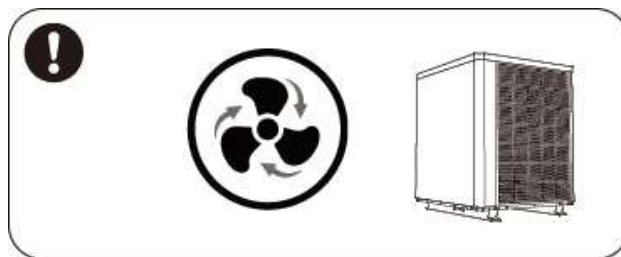

- c. Vacuum completely before welding, any maintenance or welding must be carried out by a qualified Service Technician, field welding is not allowed.

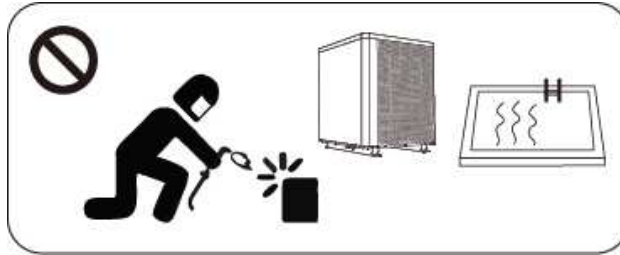

d. If a gas leak is detected during installation all work must stop and be reported to the heat pump supplier for service repair.

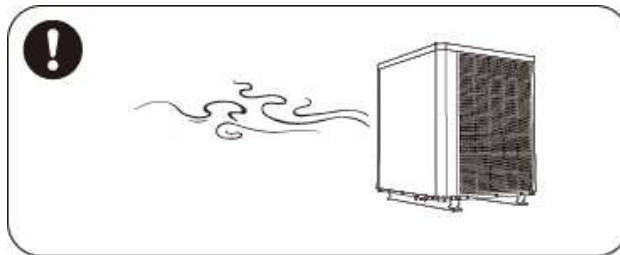

### **3. Transportation & Storage.**

- a. Secure load for transportation.
- b. Care should be taken as not to damage the heat pump during transportation.
- c. The product must be kept away from any source of fire.
- d. Storage place should be well ventilated.

### **4. Maintenance notice**

- a. For repair or scrap, please contact a qualified Service Technician for advice.
- b. Qualification requirement  
Only qualified Service Technicians are permitted to carry any service work on heat pump.
- c. Repairing or filling refrigerant R32 may only be carried out by a qualified Service Technician.

## 1. GENERAL INFORMATION

### 1.1. Components:

After unpacking, please check that all the following components are complete.

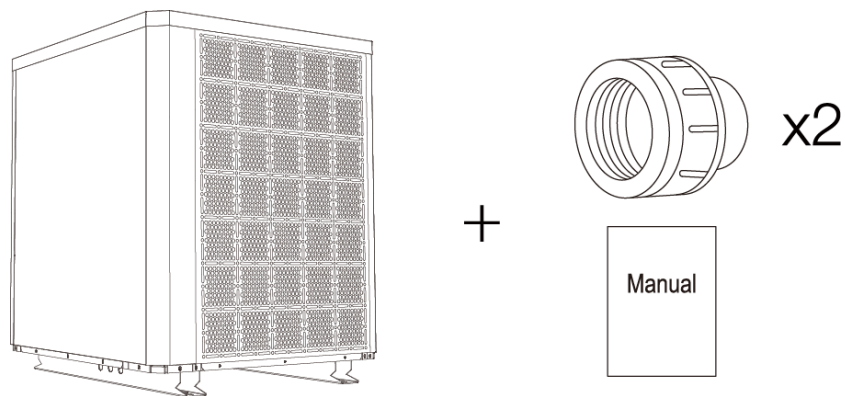



### 1.2. Operating conditions and range:

ITEMS		RANGE
<b>Operating range</b>	Air temp	-7°C~43°C
<b>Temp. setting</b>	heating	18°C~40°C
	cooling	12°C~30°C

### 1.3. Benefits in different modes:

The heat pump has three modes: Booster, Smart and Silence, which have different advantages under different conditions.

MODE	ADVANTAGES
Booster mode 	Heating capacity: 120% Fast heating
Smart mode 	Heating capacity: 100%~20% Intelligent optimization according to ambient temperature and water temperature Energy efficient saving
Silence mode 	Heating capacity: 80%~20% Use at night

## 1.4. Cautions:

**⚠** This heat pump has **Power-off memory function**. When the power is returned, the heat pump will **restart automatically**.

1.4.1. The heat pump can only be used to heat the pool water. **It can NEVER** be used to heat other flammable or turbid liquid.

1.4.2. Avoid catching the water union when moving the heat pump to avoid the titanium heat exchanger damage.



1.4.3. Don't put obstacles in front of the air inlet and outlet of the heat pump. Otherwise, heating efficiency will be sharply reduced, even stopping the system.

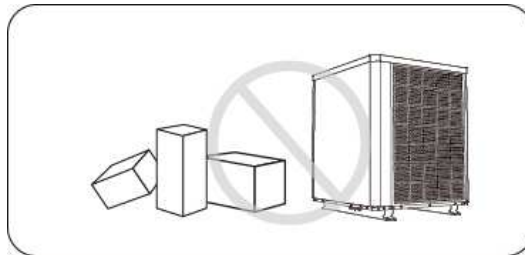

1.4.4. Do not put anything into inlet or outlet, do not remove fan cover.

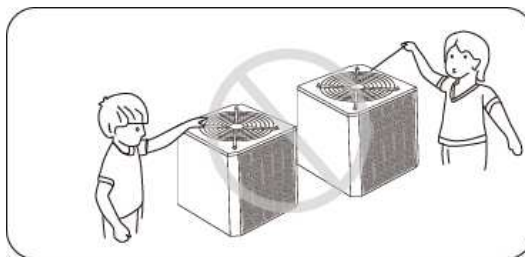

1.4.5. Do not use or store combustible gas or liquid such as thinners, paint and fuel to avoid fire.

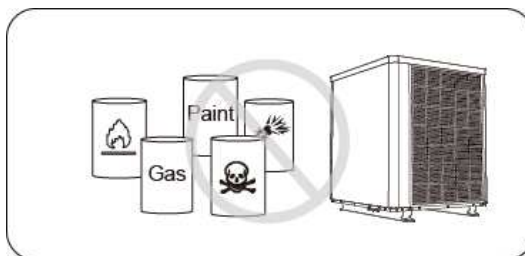

**FOR INSTALLERS AND PROFESSIONALS**

1.4.6. If any abnormal circumstances occurred,

**e.g.: abnormal noises, smells, smokes and leakage of electricity, please switch off the main power immediately and contact your local dealer.** Do not try to repair the heat pump by yourself.

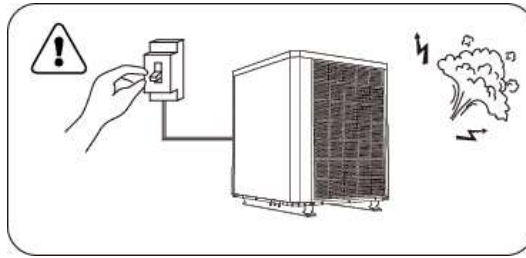

1.4.7. The main power switch should be out of the reach of children.

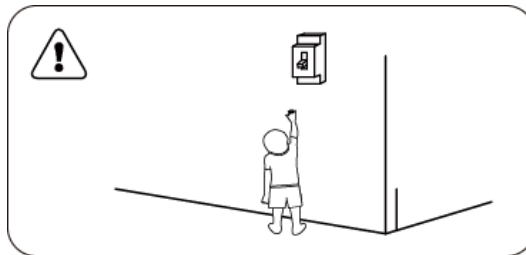

1.4.8. Cut off the power in a lightning storm, power surges can damage heat pumps.

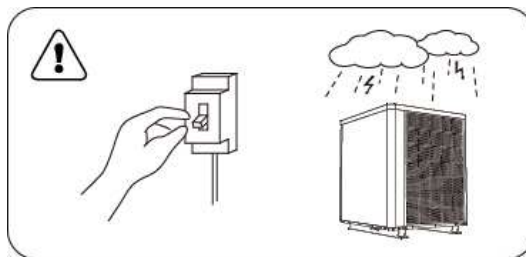

1.4.9. Please note that the following codes are no failure codes.

	<b>CODES</b>
<b>No water flow</b>	<b>E3</b>
<b>Anti-Freezing Reminder</b>	<b>Ed</b>
<b>Out of the operating temp. range</b>	<b>Eb</b>
<b>Insufficient water flow or pump blocked</b>	<b>E6</b>
<b>Abnormal outdoor power supply</b>	<b>E5</b>



## 2. OPERATIONS

### 2.1. Notice before use

**2.1.1.** Ensure no water is leaking on piping system before use, then unlock screen and power on heat pump.

**2.1.2.** Note: Only set timers if a separate water is being used.

**2.1.3.** Note: Heat pump can be controlled by water flow. If you have plumbed the heat pump into your filter pipes and intend using your filter water pump the heat pump will activate on when it detects a water flow, it will then deactivate when there is no water flow (heat pump must be left "ON" for it to do this).

### 2.2 Operation instructions



SYMBOL	DESIGNATION	FUNCTION
	ON/OFF	1. Power On/Off 2. Wifi setting
	Lock/Unlock Mode Selection	1. Press it for 3 seconds to unlock/lock screen 2. After screen is unlocked, press it to select mode. Auto (12~40°C) Heating (18~40°C) Cooling (12~30°C)
	Speed	Select Booster/Smart/Silence mode
	Up / Down	Adjust set temperature

Note:

① Screen lock:





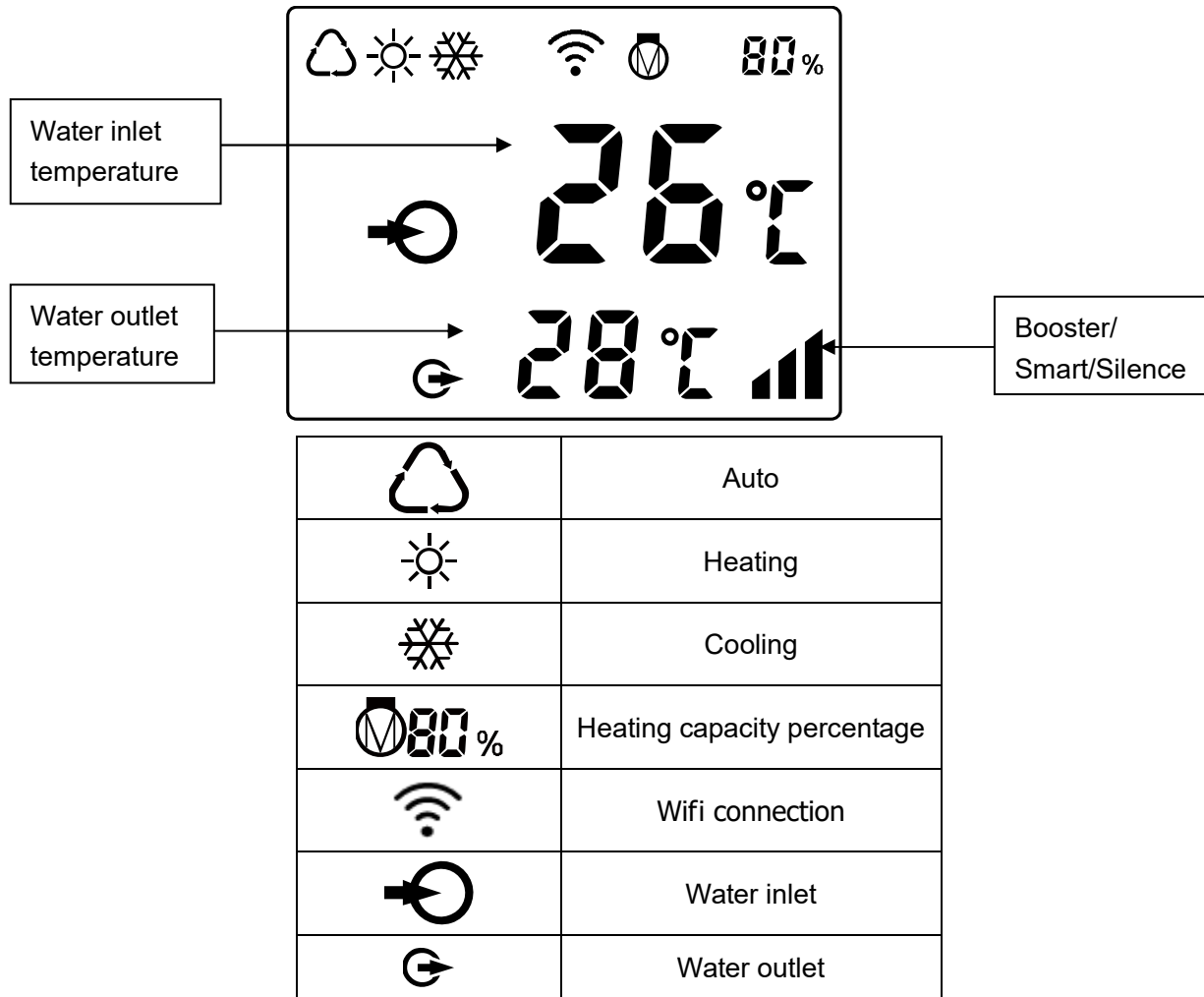

**FOR INSTALLERS AND PROFESSIONALS**

- a. If no operation in 30 seconds, screen will be locked.
- b. When HP is off, screen will be dark and "0%" will be displayed.
- c. Press  for 3 seconds to lock screen and it will go dark.

⊙ Screen unlock:

- a. Press  for 3 seconds to unlock screen and it will be light up.
- b. After screen is unlocked, any buttons will be functional.



1. Power On: Press  for 3 seconds to light up screen, then press  to power on heat pump.
2. Adjust Set Temperature: When screen is unlocked, press  or  to display or adjust the set temperature.
3. Mode Selection: Press  to select mode.
  - a. Auto : adjustable temperature range 12~40°C
  - b. Heating : adjustable temperature range 18~40°C

## FOR INSTALLERS AND PROFESSIONALS

c. Cooling : adjustable temperature range 12~30°C

4. Booster/Smart/Silence mode selection:

① Smart mode as default will be activated when heat pump is on, and screen shows .

② Press  to enter Booster mode, and screen shows , then press  to enter Silence mode, the screen shows

. Press  again, the screen shows  and returns to Smart mode.





Attention:

a. When using the booster mode, you will need to select it every time, the heat pump will not automatically enter the booster mode.

b. During the booster mode, when the heat pump reaches the set temperature, it will automatically return to the smart mode.



5. Defrosting

a. Auto Defrosting: When heat pump is defrosting,  will be flashing. After defrosting,  will stop flashing.

b. Compulsory Defrosting: When heat pump is heating, press  and  together for 5 seconds to start compulsory defrosting, and  will be flashing. After defrosting,  will stop flashing.

(Note: Compulsory defrosting intervals should be more than 30 minutes and the compressor should run for more than 10 minutes.)

6. Temperature display conversion between °C and °F:

Press "" and "" together for 5 seconds to switch between °C and °F.

7. Wifi Setting

Please kindly check the last page.

## 2.3. Daily maintenance and winterizing

### 2.3.1. Daily maintenance

 **Cut off power supply of the heat pump when performing daily maintenance**

- Clean the evaporator with household detergents or clean water, NEVER use gasoline, thinners or any similar fuel.
- Check bolts, cables and connections regularly.

### 2.3.2. Winterizing

In winter season when you do not swim, cut off power supply and drain water out of the heat pump.

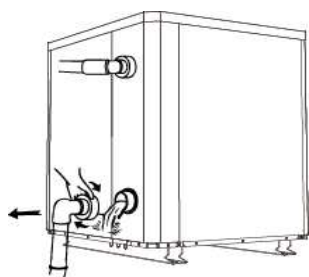

#### **Important:**

Unscrew the water union of inlet pipe to let the water flow out.

When the water in machine freezes in winter season, the titanium heat exchanger may be damaged.

### 3. TECHNICAL SPECIFICATION

Model	IPHCR13V	IPHCR17V	IPHCR21V
Operating air temperature (°C)	-7~43		
<b>Performance Condition: Air 26°C, Water 26°C, Humidity 80%</b>			
Booster (kw)	16.2	20.5	26.5
COP at Booster	6.5	6.2	6.0
Heating capacity (kw)	13.5	17.2	22.0
COP	14.6~7.5	15.1~7.0	14.6~6.8
COP at 50% capacity	11.5	11.6	11.2
<b>Performance Condition: Air 15°C, Water 26°C, Humidity 70%</b>			
Booster (kw)	12.0	15.0	19.0
COP at Booster	4.9	4.7	4.4
Heating capacity (kw)	9.8	12.5	16.0
COP	7.3~5.3	7.4~5.0	7.3~4.7
COP at 50% capacity	6.6	6.7	6.2
<b>Performance Condition: Air 35°C, Water 28°C, Humidity 80%</b>			
Cooling capacity (kw)	7.5	8.5	11.2
Sound pressure at 1m dB(A)	41.5~55.2	43.3~53.9	41.0~54.4
Sound pressure at 10m dB(A)	21.5~35.2	23.3~33.9	21.0~34.4
Power supply	230V/1 Ph/50Hz		
Rated input power at air 15°C (kw)	0.34~2.45	0.42~3.19	0.55~4.32
Rated input current at air 15°C (A)	1.48~10.7	1.83~13.9	2.40~18.8
Advised water flux (m <sup>3</sup> /h)	5~7	6.5~8.5	8~10
Water pipe in-out size (mm)	48.3		
Net Dimension LxWxH (mm)	776x687x656	776x687x656	776x687x755
Net weight (kg)	65	72	88

- The values indicated are valid under ideal conditions: Pool covered with an isothermal cover.
- Related parameters are subject to adjustment periodically for technical improvement without further notice. For details please refer to nameplate.

## 1. TRANSPORTATION

- 1.1. When storing or moving the heat pump, the heat pump should be at the upright position. Otherwise the heat pump can be damaged and will not work.
- 1.2. When moving the heat pump, do not lift or hold the water union to avoid the titanium heat exchanger damage.

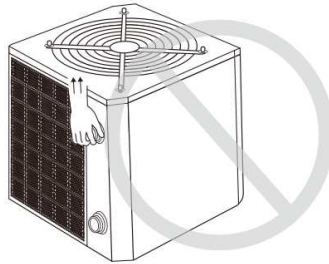

## 2. INSTALLATION AND MAINTENANCE

### 2.1. Before installation:

2.1.1. The inlet and outlet water unions **cannot** bear the weight of soft pipes. The heat pump must be connected with hard pipes!

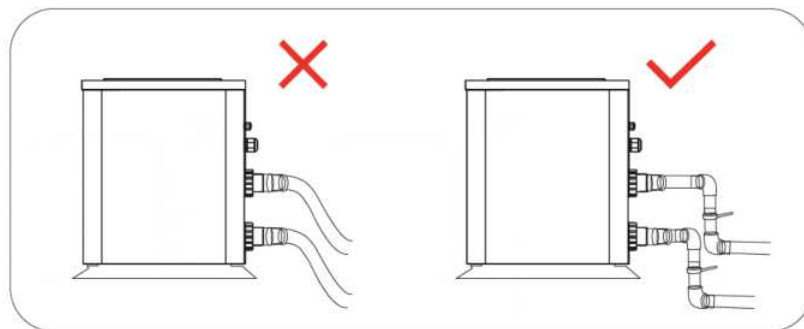

2.1.2. In order to guarantee the heating efficiency, the water pipe length should be  $\leq 10\text{m}$  between the pool and the heat pump.

## 2.2. Installation instruction

### 2.2.1. Water pipes connection and distance sketch

**!** To avoid air recirculation, the heat pump should be installed in a place with good ventilation or should reserve sufficient space for installation and maintenance. Please refer to below:

A distance at least 500 mm is required between the heat pump and the walls, shrubs, equipment, etc. This will provide sufficient intake air. In order to prevent air recirculation, the gap of air outlet should not be less than 1000 mm. We do not recommend placing the unit under the eaves, deck or porch as this will result in recirculation of the exhaust air or low efficiency of the heater, even seize.

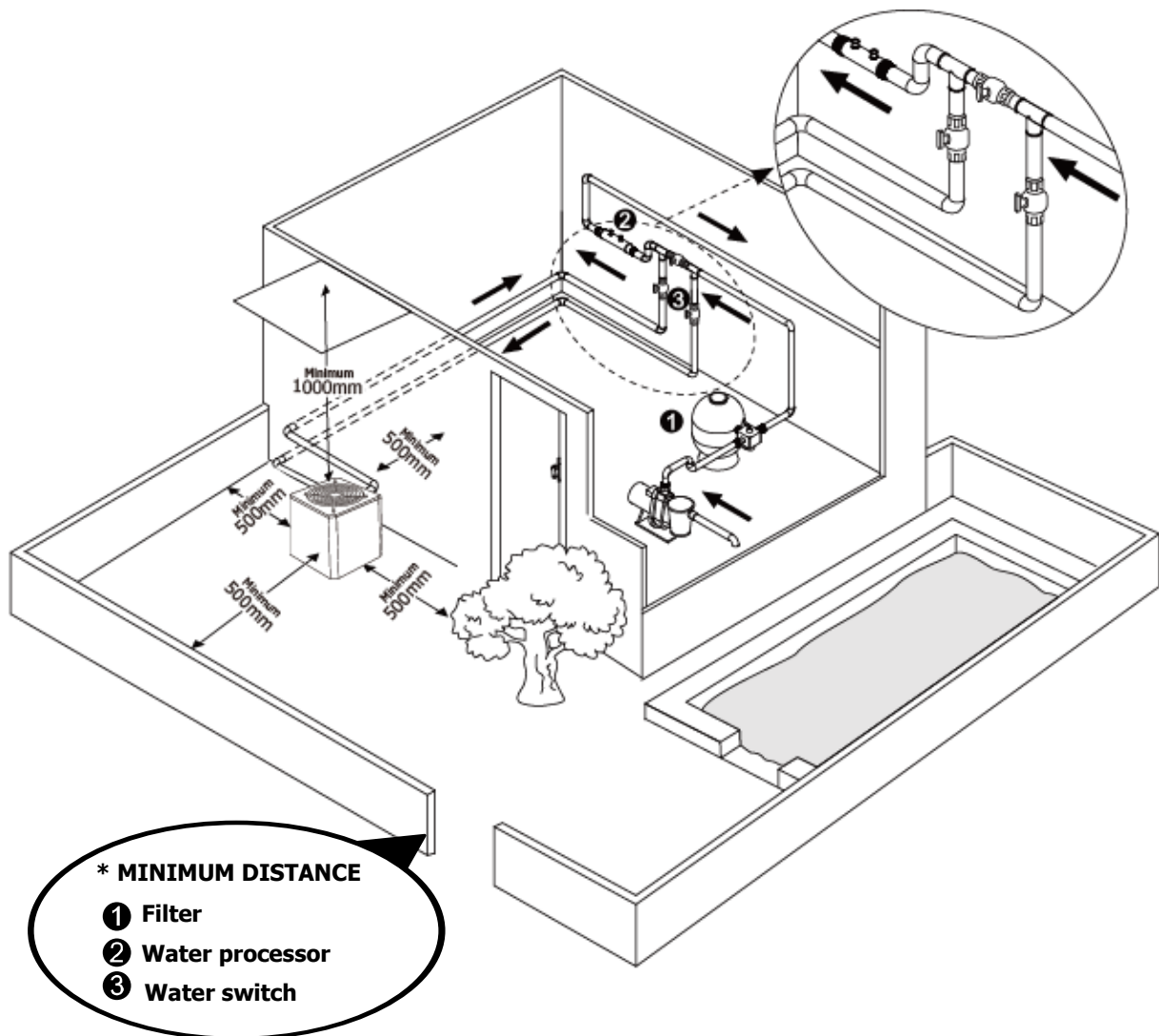

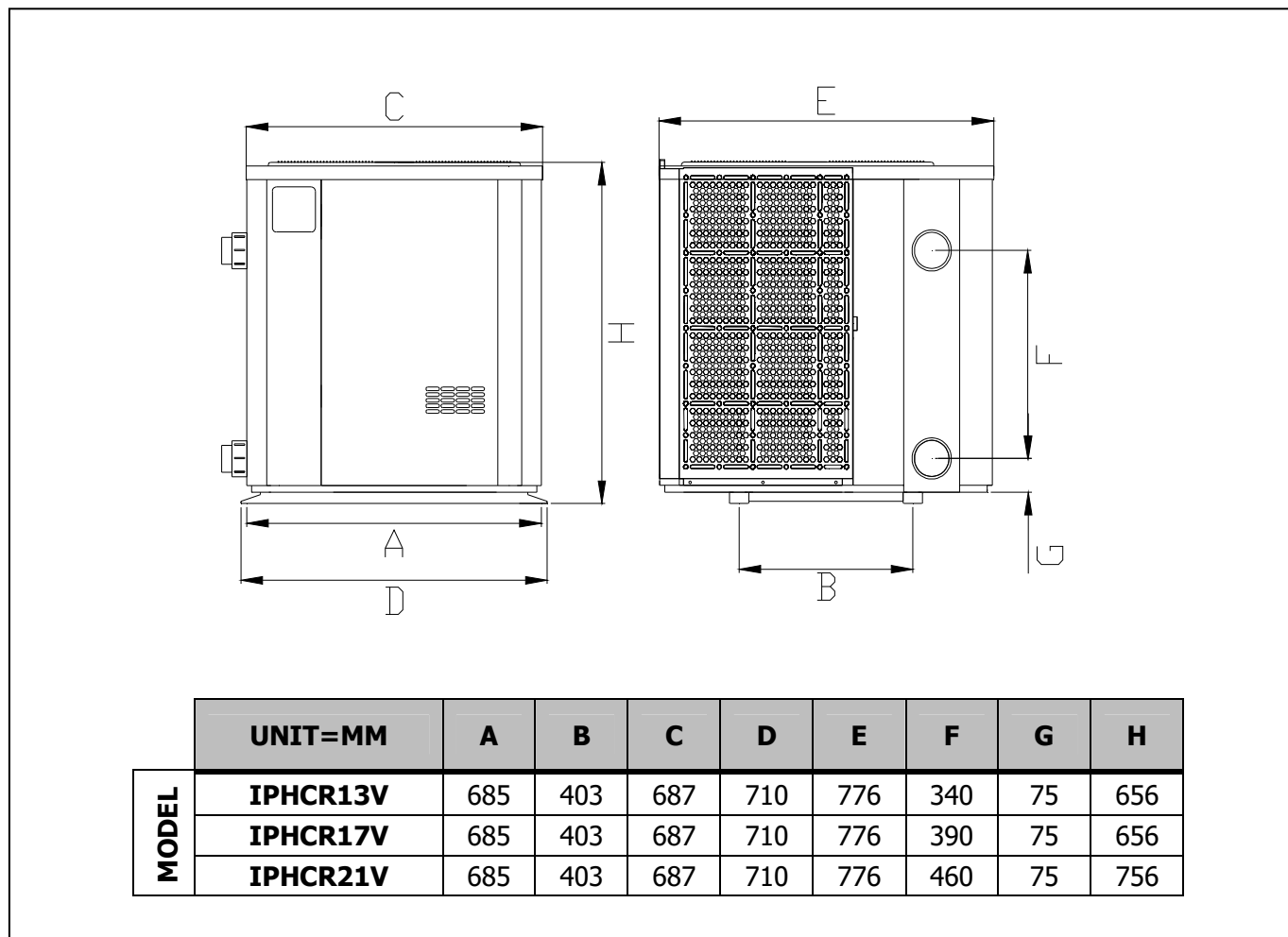

***Above data is subject to modification without notice.***

### 2.2.2. Heat pump installation

- The frame must be fixed by bolts to concrete foundation or brackets. The concrete foundation must be solid.
- The heat pump needs a water pump (**Supplied by the user**). The recommended pump specification-flux: refer to Technical Parameter, Max. lift **≥10m**.
- When the heat pump is running, there will be condensation water discharged from the bottom.

### 2.2.3. Wiring & protecting devices and cable specification

- Connect to appropriate power supply, the voltage should comply with the rated voltage of the products.
- It should be well resistance grounding.
- Wiring must be connected by a professional technician according to the circuit diagram.
- Set breaker or fuse according to the local code (leakage operating current **≤ 30mA**).

**⚠️ 1. Wiring diagram**

**A. For power supply: 230V 50Hz**

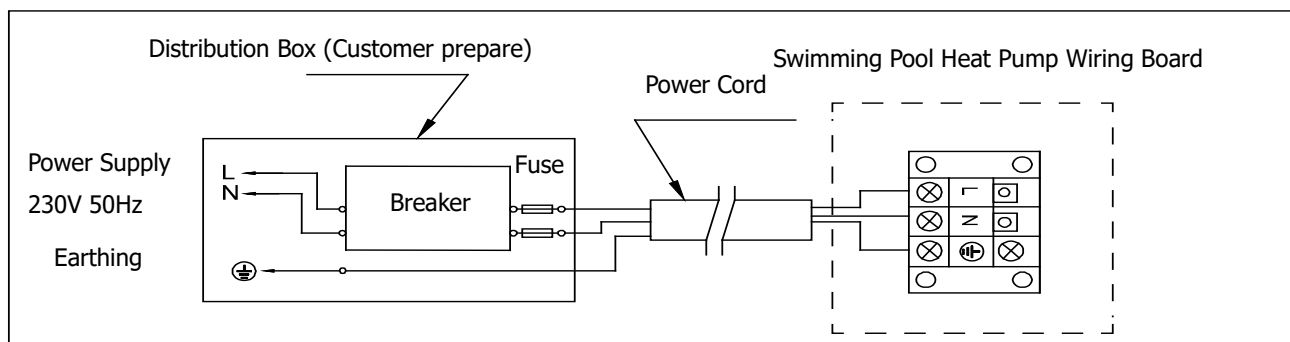

**B. For power supply: 400V 50Hz**

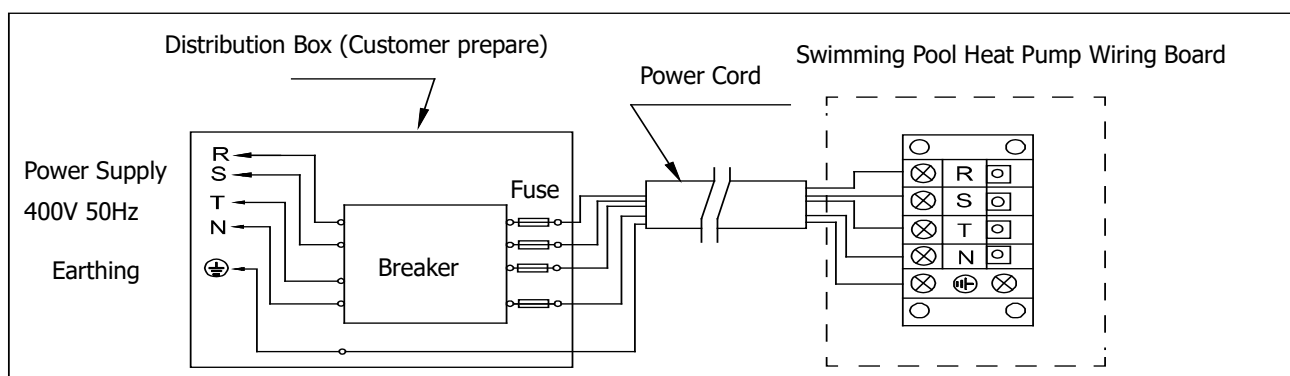

**NOTE:**

**⚠️** Must be hard wired, no plug allowed.

For the detailed wiring diagram, please refer to Appendix 1.

**2. Options for protecting devices and cable specification**

MODEL		IPHCR13V	IPHCR17V	IPHCR21V
Breaker	Rated Current A	16	21	24
	Rated Residual Action Current mA	30	30	30
Fuse A		16	21	24
Power Cord (mm <sup>2</sup> )		3×2.5	3×4	3×6
Signal cable (mm <sup>2</sup> )		3×0.5	3×0.5	3×0.5

**NOTE:** The above data is adapted to power cord ≤ 10m. If power cord is >10m, wire diameter must be increased. The signal cable can be extended to 50m at most.



## 2.3. Trial after installation

**⚠ Please check all the wirings carefully before turning on the heat pump.**

### 2.3.1. Inspection before use

- Please check if the heat pump is well installed, and check the pipe connections in accordance to the pipe diagram.
- Check the electric wiring in accordance to the electrical wiring diagram and check the earthing connection;
- Make sure that the main power is well connected;
- Check there isn't any obstacle in front of the air inlet and outlet of the heat pump

### 2.3.2. Trial

- The user is advised to start the water pump before the heat pump works, and turn off the heat pump before the water pump off in order to avoid heat pump damage.
- The user should start the water pump, and check for any leakage of water; Power on and press the ON/OFF button of the heat pump, and set desired temperature in the thermostat.
- In order to protect the heat pump, the heat pump is equipped with start delay function. When starting the heat pump, the fan will start to run in 3 minutes, in another 30 seconds, the compressor will start to run.
- After pool heat pump starts up, check for any abnormal noise from the heat pump.
- Check the temperature setting.

## 2.4. Maintenance and winterizing

### 2.4.1 Maintenance

**⚠ The maintenance should be carried out once per year by qualified professional technician.**

- Cut off power supply of the heat pump before cleaning, examination and repairing. Do not touch the electronic components until the LED indication lights on PCB turns off.

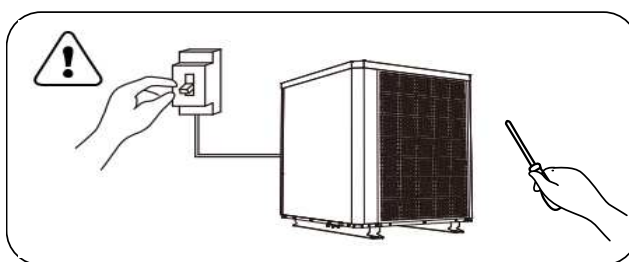

- Please clean the evaporator with household detergents or clean water, NEVER use gasoline, thinners or any similar fuel.
- Check bolts, cables and connections regularly.

### 2.4.2 Winterizing

In winter season when you don't swim, please cut off power supply and drain water out of the heat pump. When using the heat pump under 2°C, make sure there is always water flow.

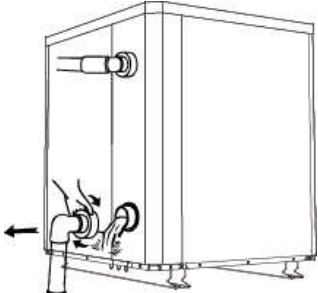

**! Important:**

Unscrew the water union of inlet pipe to let the water flow out.  
When the water in machine freezes in winter season, the titanium heat exchanger may be damaged.

## 3. TROUBLE SHOOTING FOR COMMON FAULTS

FAILURE	REASON	SOLUTION
<b>Heat pump doesn't run</b>	power cut	Wait until the power recovers
	Power switch is off	Switch on
	Fuse burned	Check and change the fuse
	The breaker is off	Check and turn on the breaker
<b>Fan running but with insufficient heating</b>	evaporator blocked	Remove the obstacles
	Air outlet blocked	Remove the obstacles
	3 minutes start delay	Wait patiently
<b>Display normal, but no heating</b>	Set temp. too low	Set proper heating temp.
	3 minutes start delay	Wait patiently

If above solutions don't work, please contact your installer with detailed information and your model number. Don't try to repair it by yourself.

**ATTENTION! Please don't try to repair the heat pump by yourself to avoid any risk.**

## 4. FAILURE CODE

NO.	DISPLAY	NOT FAILURE DESCRIPTION
1	<b>E3</b>	No water protection
2	<b>E5</b>	Power supply excesses operation range
3	<b>E6</b>	Excessive temp difference between inlet and outlet water (Insufficient water flow protection)
4	<b>Eb</b>	Ambient temperature too high or too low protection
5	<b>Ed</b>	Anti-freezing reminder
NO.	DISPLAY	FAILURE DESCRIPTION
1	<b>E1</b>	High pressure protection
2	<b>E2</b>	Low pressure protection
3	<b>E4</b>	3 phase sequence protection (three phase only)
4	<b>E7</b>	Water outlet temp too high or too low protection
5	<b>E8</b>	High exhaust temp protection
6	<b>EA</b>	Evaporator overheat protection (only at cooling mode)
7	<b>P0</b>	Controller communication failure
8	<b>P1</b>	Water inlet temp sensor failure
9	<b>P2</b>	Water outlet temp sensor failure
10	<b>P3</b>	Gas exhaust temp sensor failure
11	<b>P4</b>	Evaporator coil pipe temp sensor failure
12	<b>P5</b>	Gas return temp sensor failure
13	<b>P6</b>	Cooling coil pipe temp sensor failure
14	<b>P7</b>	Ambient temp sensor failure
15	<b>P8</b>	Cooling plate sensor failure
16	<b>P9</b>	Current sensor failure
17	<b>PA</b>	Restart memory failure
18	<b>F1</b>	Compressor drive module failure
19	<b>F2</b>	PFC module failure
20	<b>F3</b>	Compressor start failure
21	<b>F4</b>	Compressor running failure
22	<b>F5</b>	Inverter board over current protection
23	<b>F6</b>	Inverter board overheat protection
24	<b>F7</b>	Current protection
25	<b>F8</b>	Cooling plate overheat protection
26	<b>F9</b>	Fan motor failure
27	<b>Fb</b>	Power filter plate No-power protection
28	<b>FA</b>	PFC module over current protection

APPENDIX 1: HEATING PRIORITY WIRING DIAGRAM (OPTIONAL)

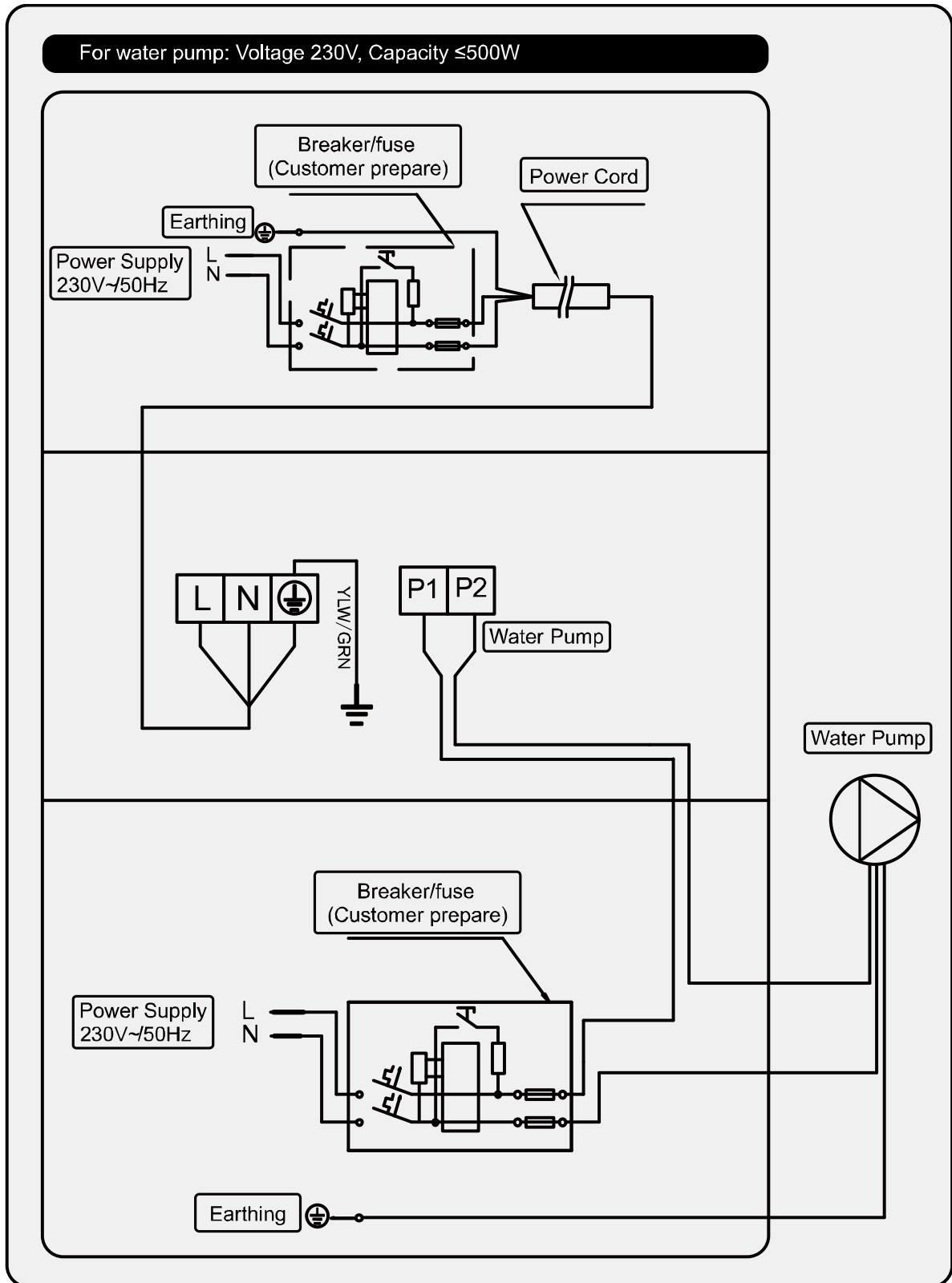

APPENDIX 2: HEATING PRIORITY WIRING DIAGRAM(OPTIONAL)

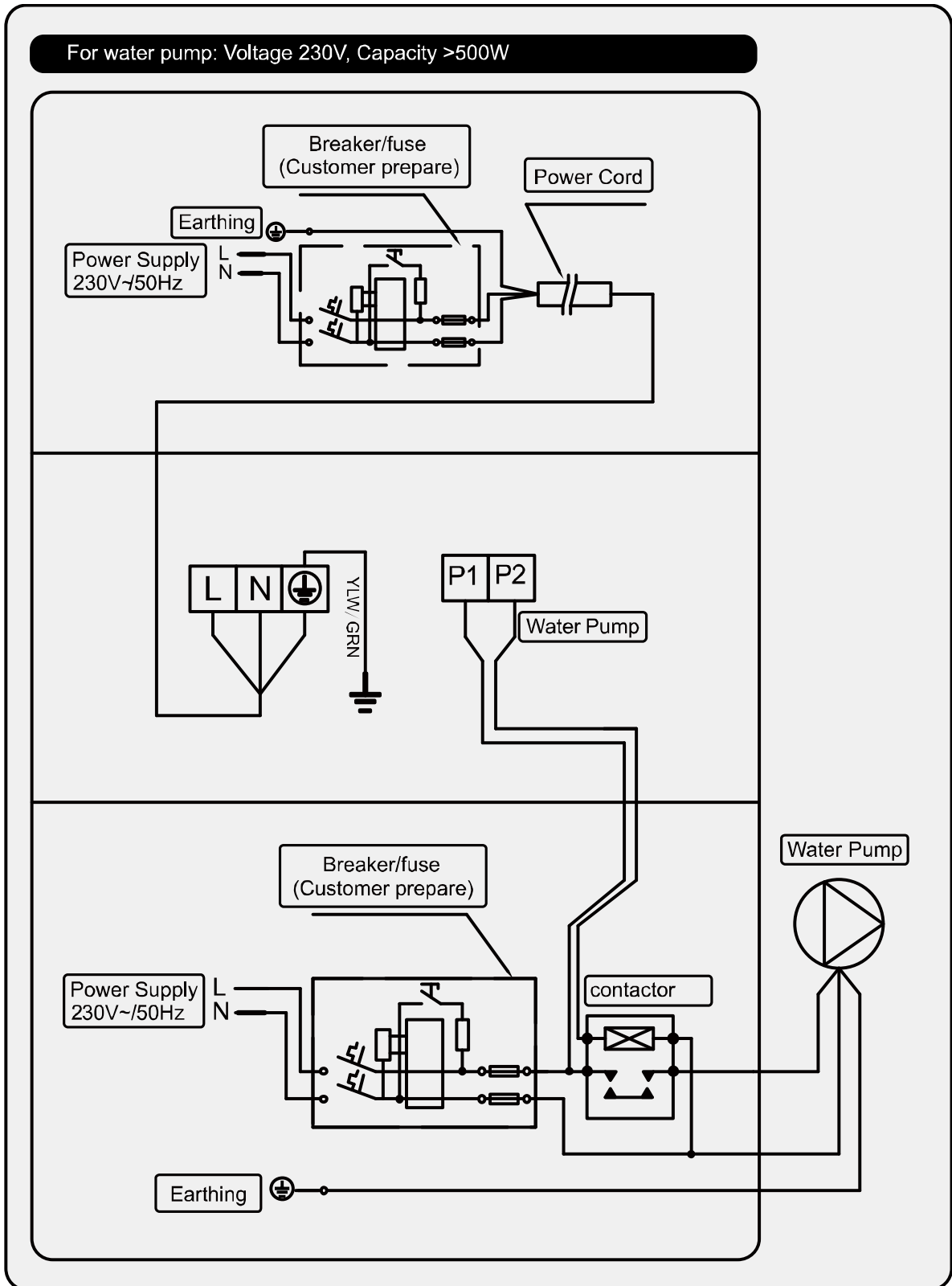

APPENDIX 3: HEATING PRIORITY WIRING DIAGRAM(OPTIONAL)

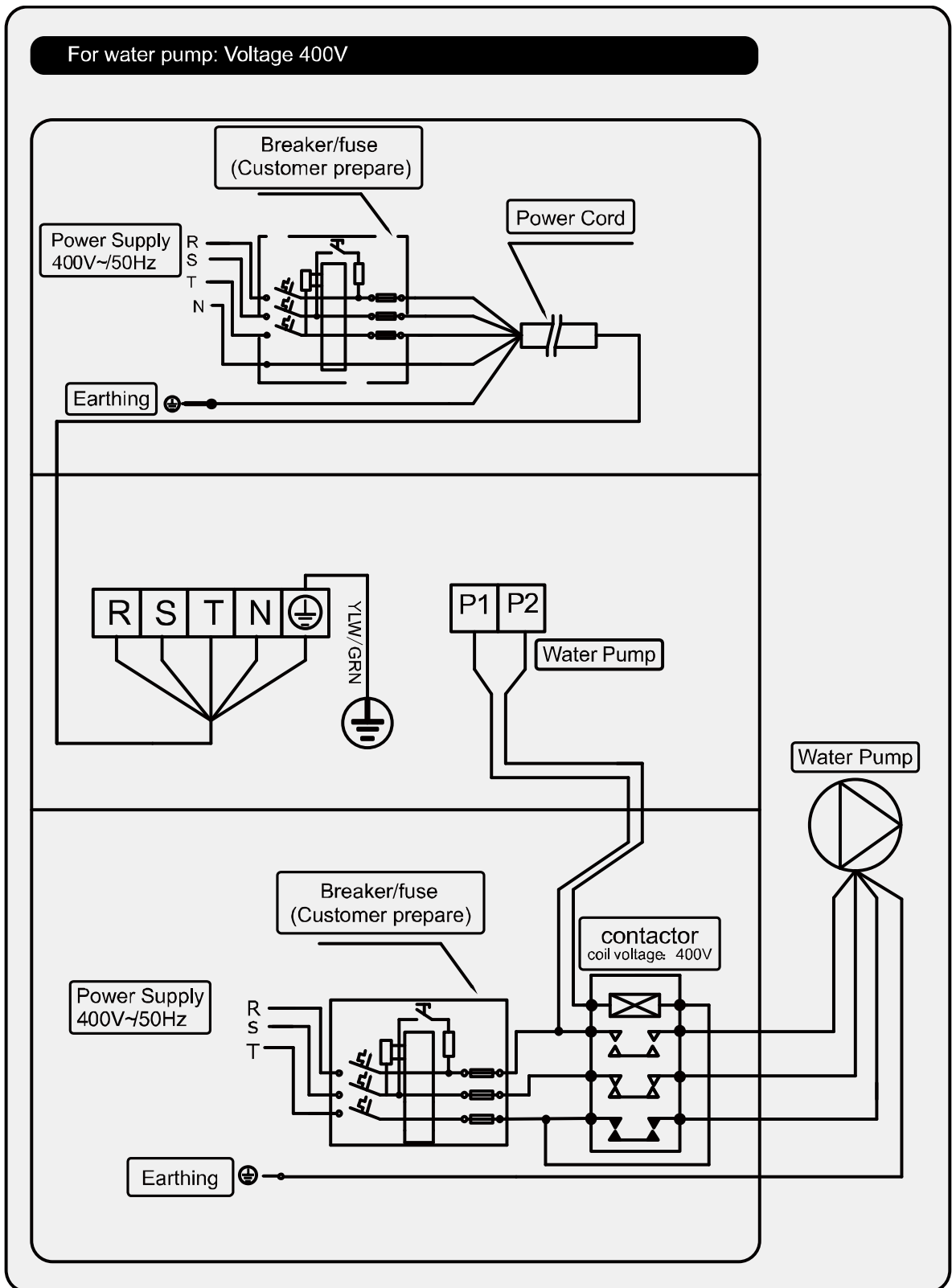

Parallel connection with filtration clock

A: Water pump timer

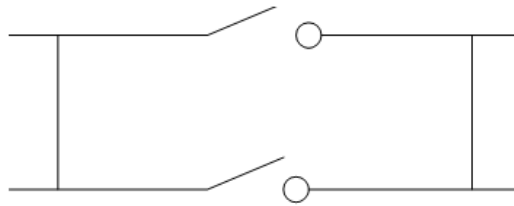

B: Water pump wiring of Heat Pump

Note: The installer should connect A parallel with B (refer to the picture above). To start the water pump, condition A or B is connected. To stop the water pump, both A and B should be disconnected.

## 5. WIFI SETTING

### 1) APP Download



For Android mobile download from



For iPhone download from



### 2) Account registration

#### a) Registration by Cell phone number/Email

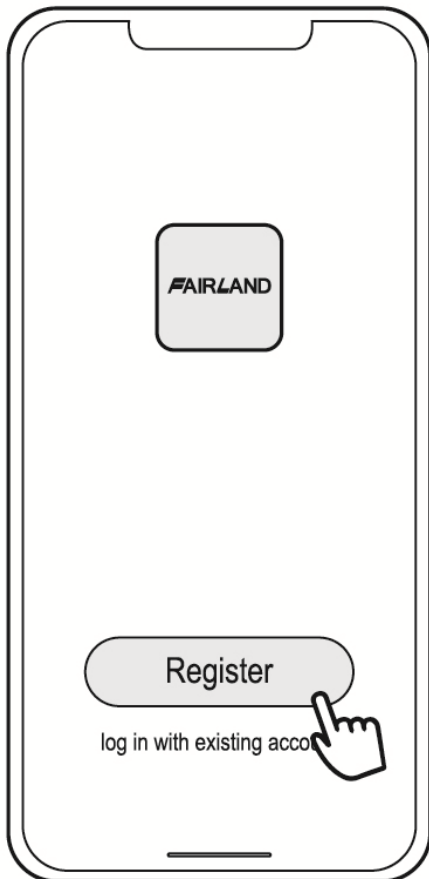



b) Cell phone number registration

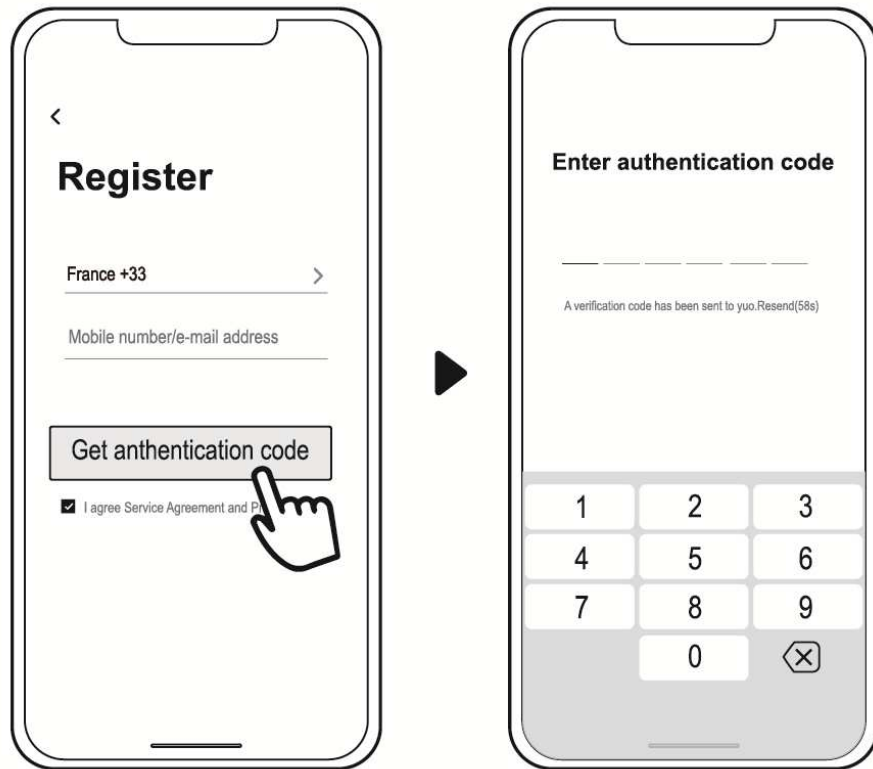

3) Create family

Please set family name and choose the room of device

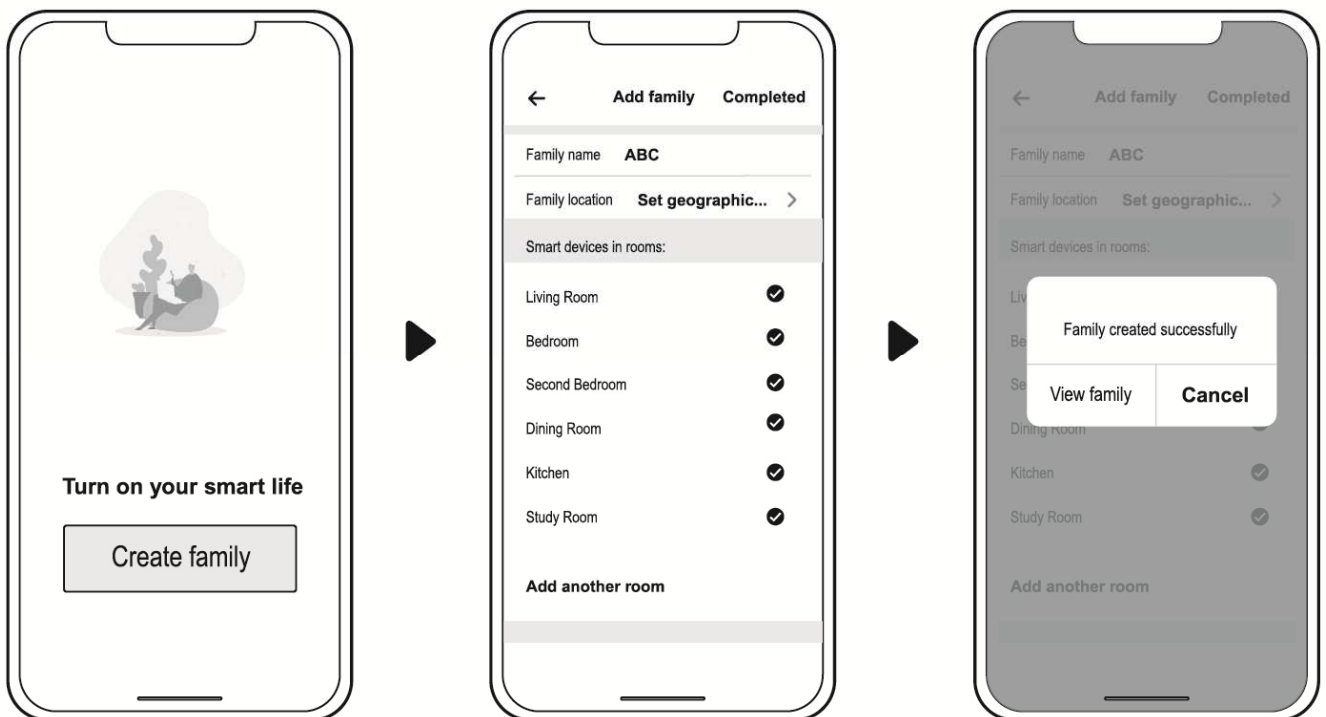

4) APP Binding

Please make sure your cell phone has connected to the Wifi

a) Wifi connection:

Press  for 3 seconds,  will be flashing to enter Wifi binding program.



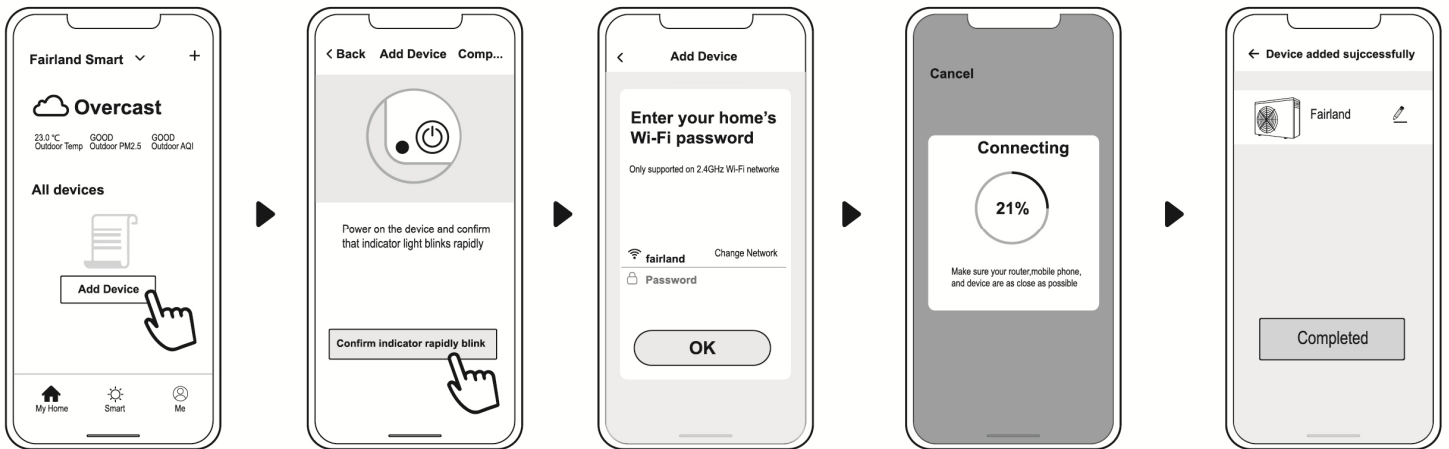

b) Click "Add device", follow indication to finish binding.  will display on the screen once Wifi is conected.



c) If connection fails, please make sure your network name and password is correct. And your router, mobile phone and device are as close as possible.

d) Wifi rebinding (When Wifi password changes or network configuration changes):

Press  for 10 seconds,  will be flashing slowly for 60 seconds. Then  will be off. The original binding will be removed. Follow step above for rebinding.

Note: Please make sure the router is configured at 2.4G.

5) Operation

For heat pump with Heating & Cooling function.

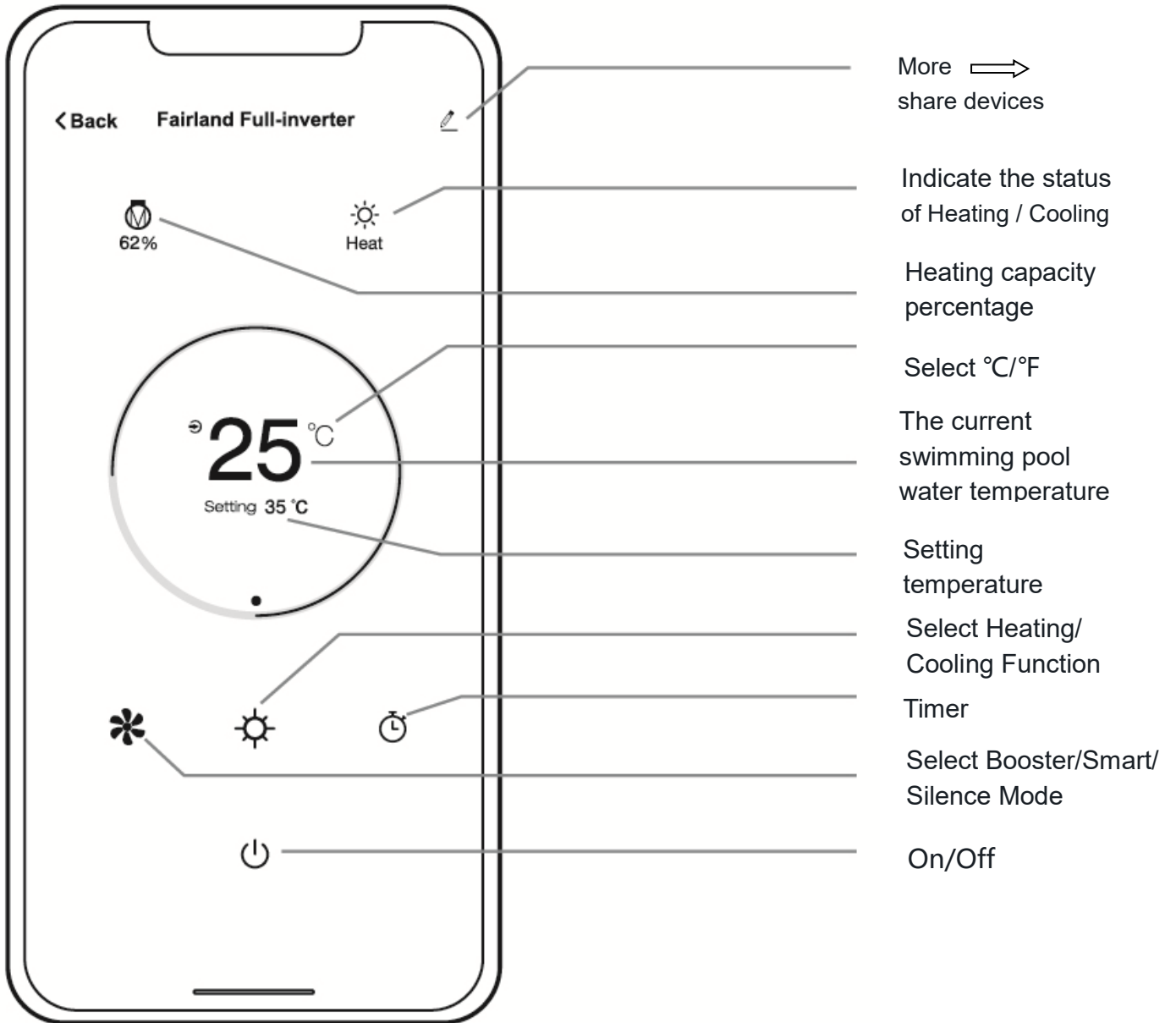

## FOR INSTALLERS AND PROFESSIONALS

### 6) Share devices to your family members

After binding, if your family members also want to control the device.

Please let your family members register the APP first, and then the administrator can operate as below:

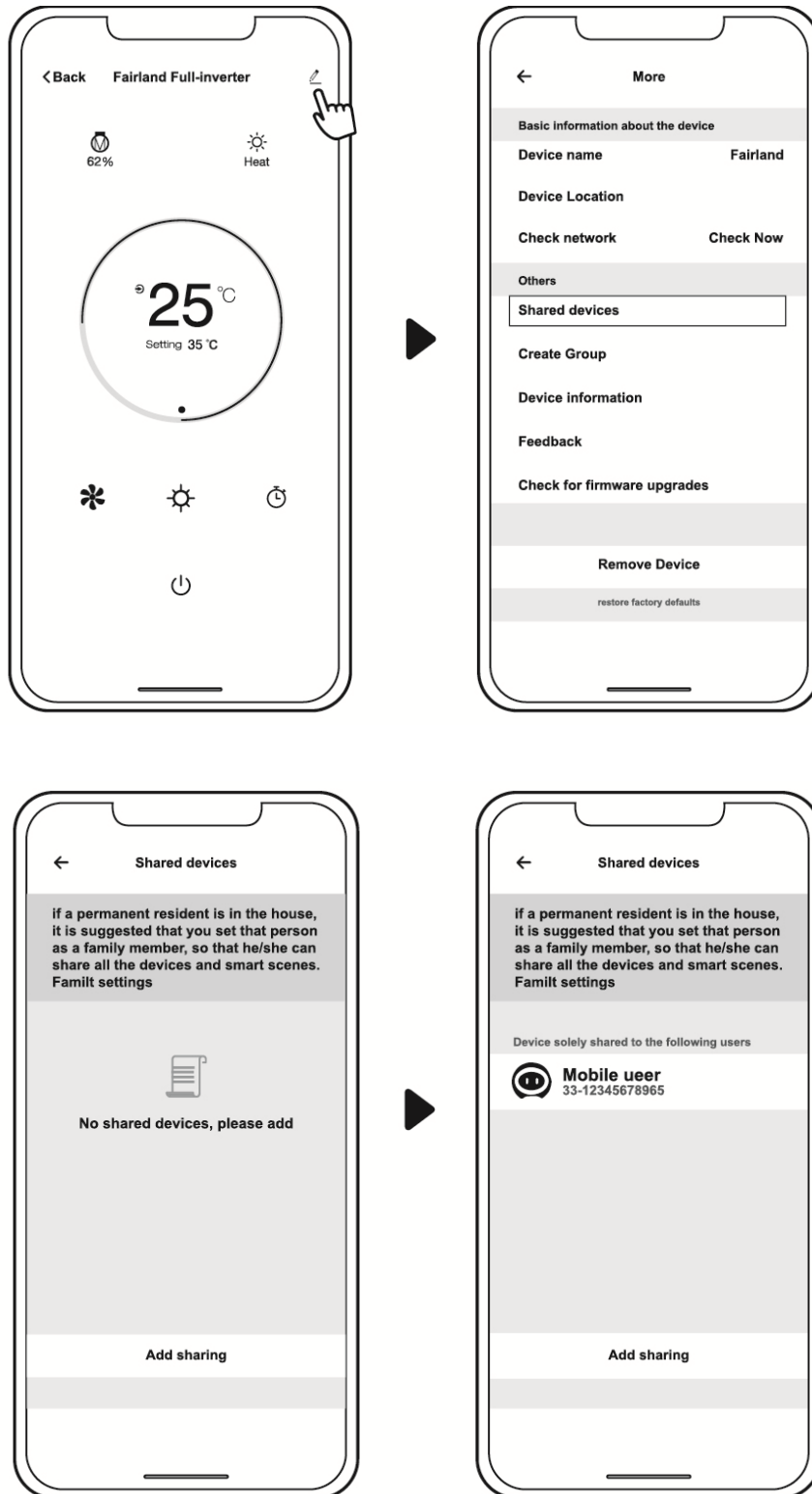

Then your family members can log in as below:

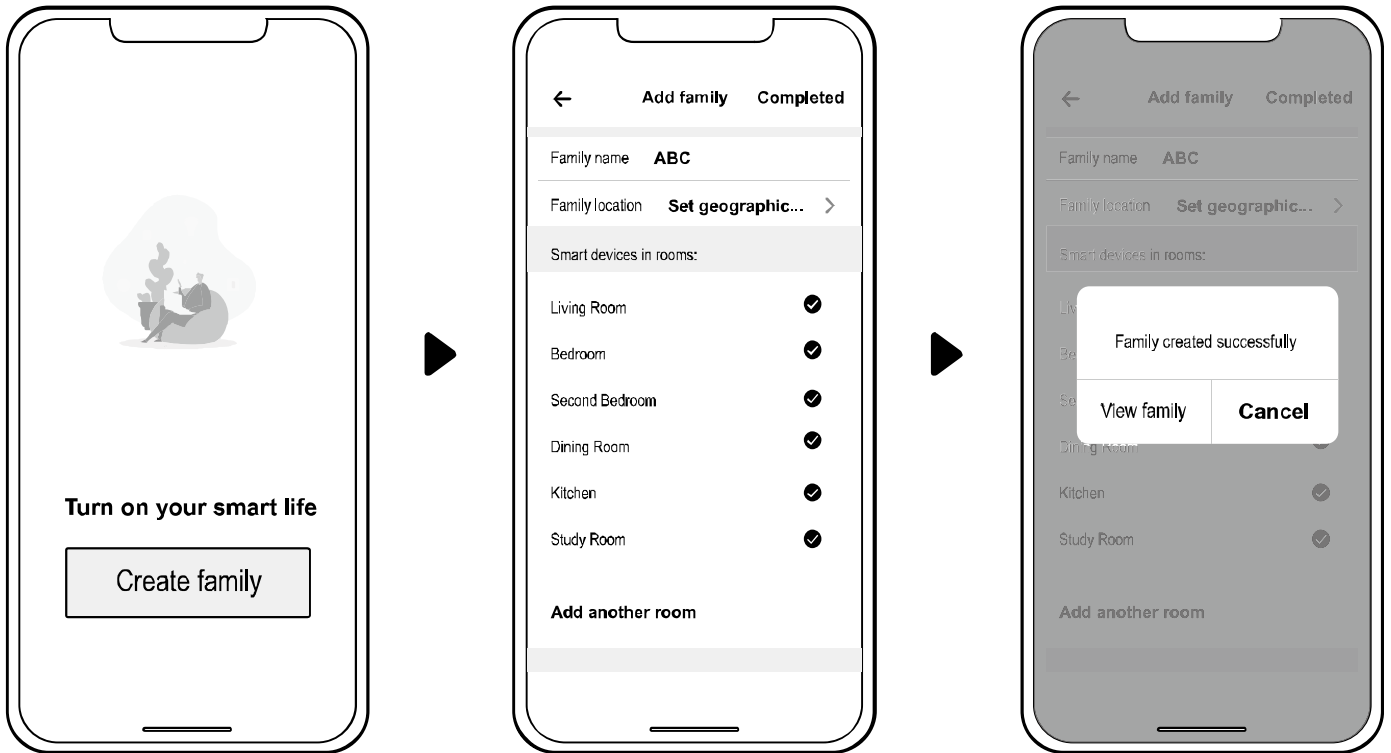

- Note: 1. The weather forecast is just for reference.  
2. APP is subject to updating without notice.





**FAIRLAND®**  
**INVERTER SWIMMING POOL**